

EEM37-2KF0B015A

EES/EEM37

MOTOR FEEDBACK SYSTEMS ROTARY HIPERFACE DSL®

SICK
Sensor Intelligence.

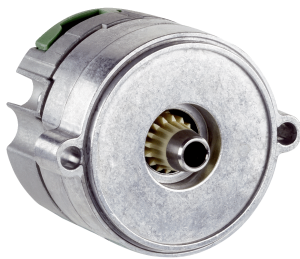

Ordering information

Type	Part no.
EEM37-2KFOB015A	1086279

Other models and accessories → www.sick.com/EES_EEM37

Illustration may differ



Detailed technical data

Safety-related parameters

Safety integrity level	SIL2 (IEC 61508), SILCL3 (EN 62061) ¹⁾
Category	3 (EN ISO 13849)
Systematic suitability	SC 3 (IEC61508)
Test rate	24 h
Maximum demand rate	216 µs
Performance level	PL d (EN ISO 13849)
Basis for safety function	Safe singleturn absolute position
Safety-related resolution	Channel 1 = 15 or 17 bit, channel 2 = 15 or 17 bit
PFH_D: Probability of dangerous failure per hour	26 x 10 ⁻⁹ ²⁾
T_M (mission time)	20 years
Safety-related accuracy	1° ³⁾

¹⁾ For more detailed information on the exact configuration of your machine/unit, please consult your relevant SICK branch office.

²⁾ The values displayed apply to a diagnostic degree of coverage of 90%, which must be achieved by the external drive system.

³⁾ The safety-related accuracy indicates the maximum position error limit with which safety functions can be supported.

Performance

Resolution per revolution	15 bit
Number of the absolute ascertainable revolutions	4,096
Signal noise (σ)	± 20 " (nominal position, 25 °C, filter setting 21 kHz)
System accuracy	Nominal position, 25 °C, filter setting 21 kHz ± 280 " ¹⁾ Nominal position, 25 °C, filter setting 1 kHz ± 190 "
Speed when switching on/resetting the motor feedback system	≤ 6,000 min ⁻¹
Available memory area	8,192 Byte
Measurement step per revolution	32,768

¹⁾ See diagram for error limits (default filter setting: 21 kHz).

Interfaces

Code sequence	Increasing, when turning the shaft For clockwise rotation, looking in direction "A" (see dimensional drawing)
Communication interface	HIPERFACE DSL®
Initialization time	Max. 500 ms ¹⁾
Measurement external temperature resistance	32-bit value, without prefix (1 Ω) 0 ... 209.600 Ω ²⁾

¹⁾ From reaching a permitted operating voltage.

²⁾ Without sensor tolerance; at -17 °C ... +167 °C: NTC +2K (103 GT); PTC+3K (KTY84/130/PT1000).

Electrical data

Connection type	Male connector, 4-pin
Supply voltage	7 V ... 12 V
Warm-up time voltage ramp	Max. 180 ms ¹⁾
Power consumption	≤ 150 mA ²⁾

¹⁾ Duration of the voltage ramp between 0 and 7.0 V, see diagram "Current consumption" in the diagram section.

²⁾ Current rating applies when using interface circuit suggestions as shown in HIPERFACE DSL® manual (8017595).

Mechanical data

Shaft version	Tapered shaft
Dimensions	See dimensional drawing
Weight	≤ 0.1 kg
Moment of inertia of the rotor	1 gcm ²
Operating speed	≤ 12,000 min ⁻¹
Angular acceleration	≤ 500,000 rad/s ²
Permissible radial shaft movement	± 0.15 mm
Permissible axial shaft movement	± 0.5 mm

Ambient data

Operating temperature range	-40 °C ... +115 °C ¹⁾
Storage temperature range	-40 °C ... +120 °C, without package
Relative humidity/condensation	85 %, Condensation not permitted
Resistance to shocks	100 g, 6 ms (according to EN 60068-2-27)
Frequency range of resistance to vibrations	50 g, 10 Hz ... 2,000 Hz (according to EN 60068-2-6)
EMC	According to EN 61000-6-2: 2016, EN 61000-6-4: 2006, IEC 6100-6-7: 2014 ²⁾
Enclosure rating	IP30, When cover is closed and mating connector is attached (acc. to EN 60529-1) ³⁾

¹⁾ For typical values for self-heating, see diagram "Electrical self-heating" in the diagram section. see section "Mounting" in the operating instructions (8021414/8021265).

²⁾ According to the listed standards, EMC is guaranteed if the motor feedback system with mating connector inserted is connected to the central grounding point of the motor controller via a cable shield. If other shielding concepts are used, users must perform their own tests. Class A device.

³⁾ When using the strands (2079920).

Classifications

ECI@ss 5.0	27270590
ECI@ss 5.1.4	27270590

Attachment specifications

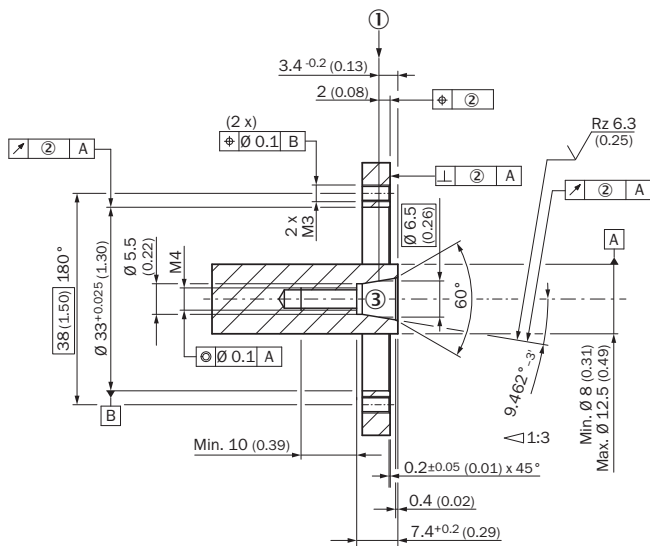

Read out axial position: positive value shows movement of rotor away from the motor flange; negative value shows movement of rotor towards the motor flange

- ① Nominal position
- ② The size of the tolerance reduces the permissible wave movement, see data sheet
- ③ Threaded holes in accordance with DIN 13 with recesses in accordance with DIN 76 min. 1.05 x thread diameter

PIN assignment

Supply / Communication pin assignment

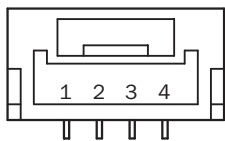

Integrated in motor cable = J, K

PIN	Signal	Explanation
1		Not connected - no function
2	+U _S /DSL+	Supply 7 V ... 12 V
3	GND/DSL-	Ground connection
4		Not connected - no function

Recommended outer diameter of set of stranded wires: 4 mm +0/-1.5 mm
Recommended mating connector: JST (GHR-04V-S)

Temperature sensor pin assignment

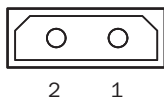

PIN	Signal	Explanation
1	T+	Thermistor connection
2	T-	Thermistor connection (to ground)

Recommended outer diameter of set of stranded wires: 2.2 mm ± 0.1 mm

PIN	Signal	Explanation
Recommended mating connector: Harwin M80-8990205		

Diagrams

Power consumption

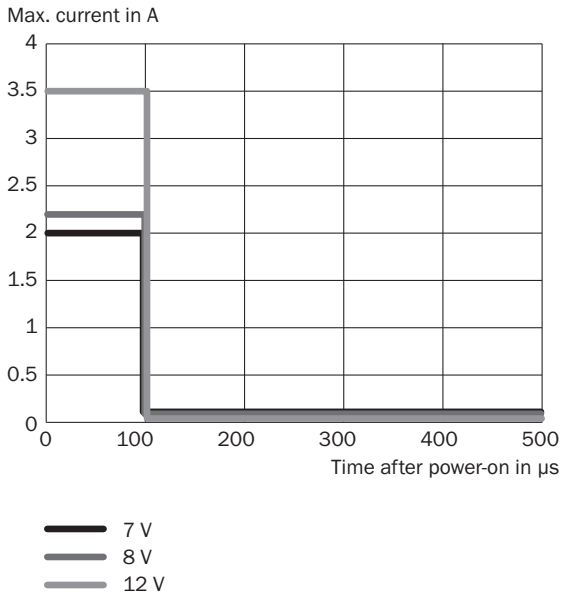

This diagram shows the switch-on current
Latency period vs. filter frequency

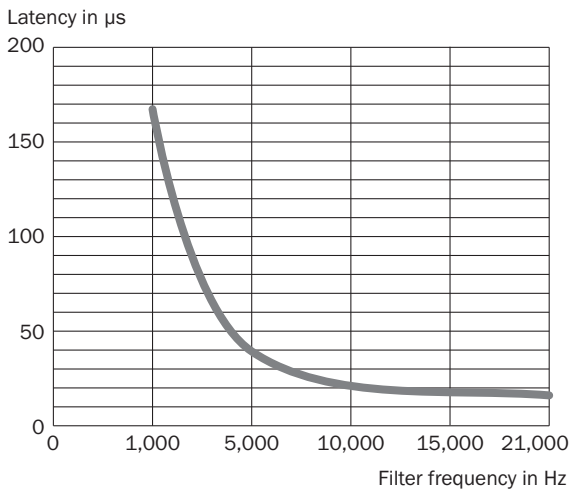

Adjustable filter frequencies 21 kHz, 15 kHz, 10 kHz, 5 kHz and 1 kHz - Default setting 21 kHz

Error limits

Typ. effect of temperature on accuracy, normed

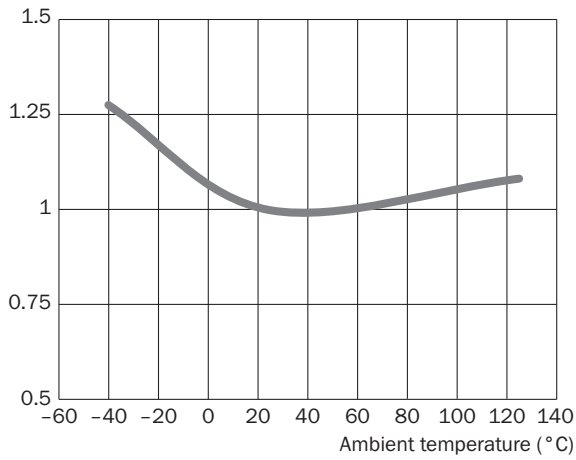

Error limits

Typ. effect of axial position on accuracy, normed

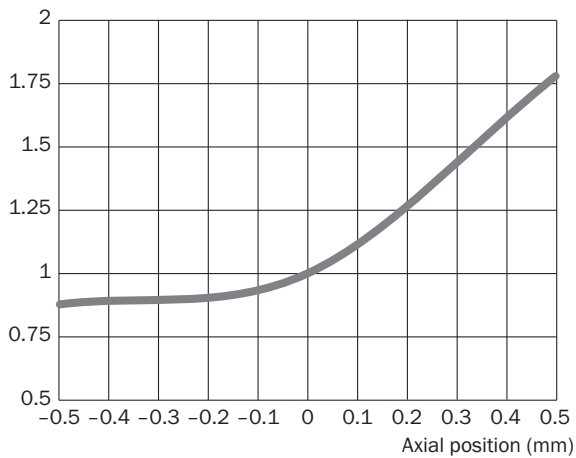

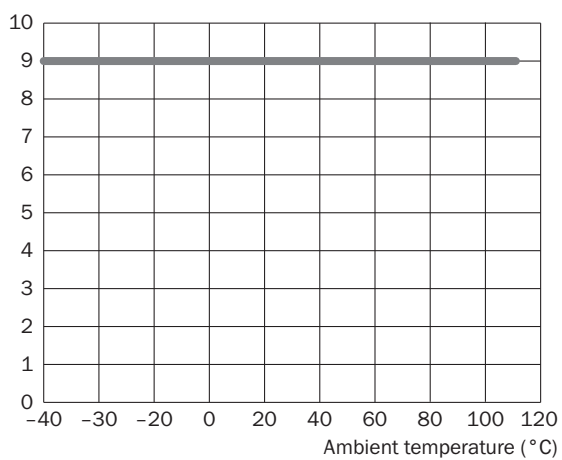

Electrical self-heating

Typ. electrical self-heating, kelvin (K)



Recommended accessories

Other models and accessories → www.sick.com/EES_EEM37

	Brief description	Type	Part no.
Nuts and screws			
	100 pieces, Screws with Precote 85-8 coating; M4*14	BEF-MK-S03	2077358
	10 pieces, Screws with Precote 85-8 coating; M4*14	BEF-MK-S07	2088239
	500 pieces, Screws with Precote 85-8 coating; M4*14	BEF-MK-S08	2088240
Other mounting accessories			
	Test gauge for SEK/SEL34, SEK/SEL37, and EES/EEM37	BEF-MW-PL	2084768
Plug connectors and cables			
	Head A: female connector, stranded wire, 4-pin, straight Head B: Flying leads Cable: HIPERFACE DSL [®] , unshielded, 0.2 m	DOL-0B02-G0M2XC2	2079920
Programming and configuration tools			
	SVip [®] LAN programming tool for all motor feedback systems	PGT-11-S LAN	1057324
	SVip [®] WLAN programming tool for all motor feedback systems	PGT-11-S WLAN	1067474

SICK AT A GLANCE

SICK is one of the leading manufacturers of intelligent sensors and sensor solutions for industrial applications. A unique range of products and services creates the perfect basis for controlling processes securely and efficiently, protecting individuals from accidents and preventing damage to the environment.

We have extensive experience in a wide range of industries and understand their processes and requirements. With intelligent sensors, we can deliver exactly what our customers need. In application centers in Europe, Asia and North America, system solutions are tested and optimized in accordance with customer specifications. All this makes us a reliable supplier and development partner.

Comprehensive services complete our offering: SICK LifeTime Services provide support throughout the machine life cycle and ensure safety and productivity.

For us, that is “Sensor Intelligence.”

WORLDWIDE PRESENCE:

Contacts and other locations –www.sick.com